

ROMIL LiQuiSure™ Equipment and Accessories

Designed for High Purity Containment & Dispensing

To maintain the high purity of ROMIL products during use and handling, we have developed a special range of equipment and accessories under the LiQuiSure™ brand. These are very different from the ordinary laboratory and solvent handling equipment found in other catalogues. All have been designed for the safe, accurate and reliable dispensing of high purity solvents and acids without introducing contamination.

Whether the container size is 30ml to 2000LT and whether the dispensing operation is manual or automatic, numerous options are available within the LiQuiSure™ range.

Users of large volumes of high purity solvents will be interested in the ROMIL LiQuiShuttle™ system. Simply choose the containers and we arrange the logistical support to ensure that solvent is delivered when it is needed and empty containers are taken back for re-use. Because packaging waste is almost eliminated, this option is specially of interest to organisations operating environmental management systems to the ISO 14001 standard.

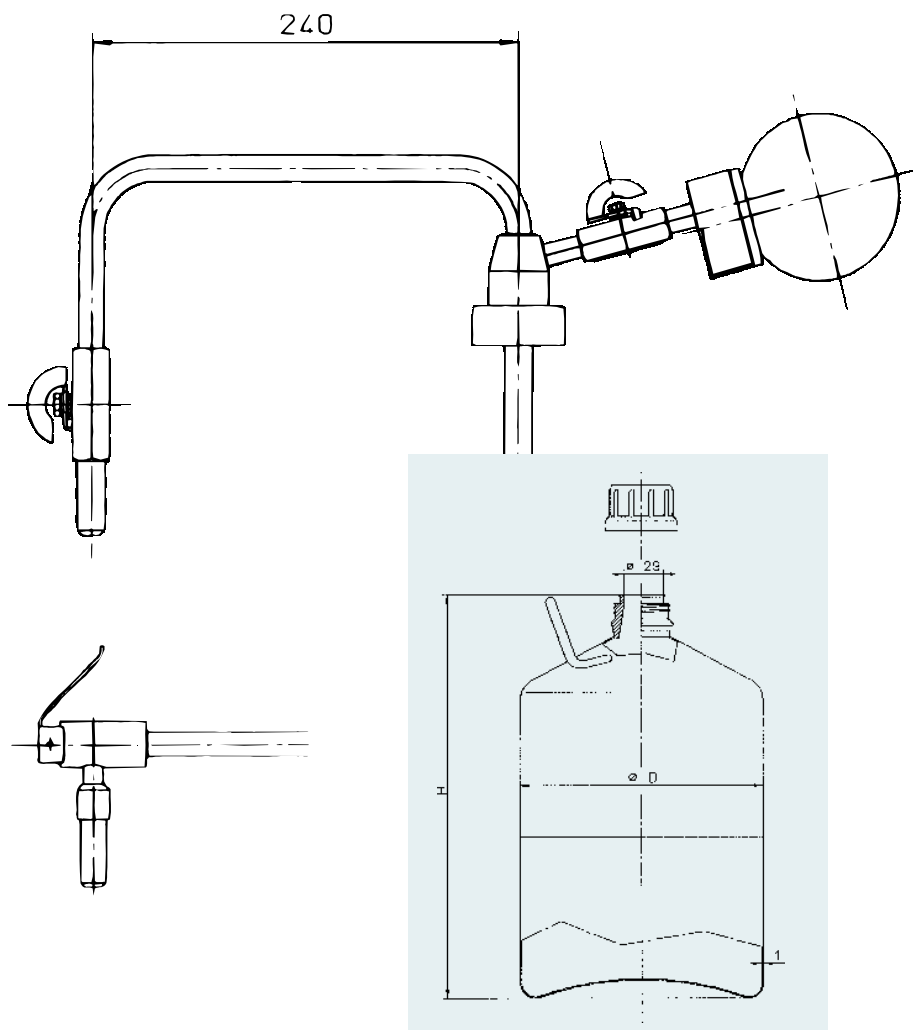

Bottle Key, LiQuiSure

PKEY

each Application: Fits most ROMIL bottle caps. Aids release of tight and difficult to remove closures.



Dispenser, stainless steel, LiQuiSure

(state flask size)

Specially designed for dispensing from ROMIL LiQuiSure™ flasks (supplied separately, see Flask, stainless steel, LiQuiSure) and to retain the original high purity of the packaged solvent. Only stainless steel and PTFE components are in contact with the solvent. Choose from two nozzle types; ball valve (type K) or sprung shut-off with integral flame arrester (type S). Dispensing is by gas pressurisation supplied either by hand pump which uses ambient air or coil tube which can take inert gas such as nitrogen or argon. The pressure is maintained in the flask by a shut off valve (1). The dip tube is an integral part of the dispenser so it is important to state the flask size when ordering. Hand pumps and coil tubes are interchangeable and are also available separately.



PFDP



PFDT



PFHP



PFCT



1

	Nozzle	Pressurisation by (supplied with dispenser)	Code
each	type K	coil tube	PFDTK
each	type K	hand pump	PFDPK
each	type S	coil tube	PFDTS
each	type S	hand pump	PFDPS
Accessories:			
each	Dispenser Coil Tube		PFCT
each	Dispenser Hand Pump		PFHP

Dispensing System, automated, LiQuiSure

This system has been designed by ROMIL to meet a demand for automated and unattended dispensing of large volumes of high purity solvent in the commercial production of peptides and genome sequencing. It is also applicable to other areas of manufacture of high added value materials where continuous operation combined with low risk exposure to hazardous vapours is equally important. Being of modular design it is extremely flexible in its operation and can be configured for numerous applications, dispensing ports and drum capacities. The control module features LED displays and push buttons which both control and indicate the operation status and allows for full manual override. All electronic components are housed in polycarbonate (EEx e II T6) sealed boxes designed to meet the requirements for Zone 2 hazardous areas thus ensuring safe operation with flammable solvents. The box material is also impact resistant, self extinguishing and resistant to most acids. External components such as LED displays, push buttons and valves have an IP67 rating for indoor and outdoor environments. Usually supplied on free loan as part of a ROMIL LiQuiShuttle™ Agreement to supply bulk quantities of high purity solvent, the returnable stainless steel drums ensure product consistency and integrity with virtually no packaging waste.

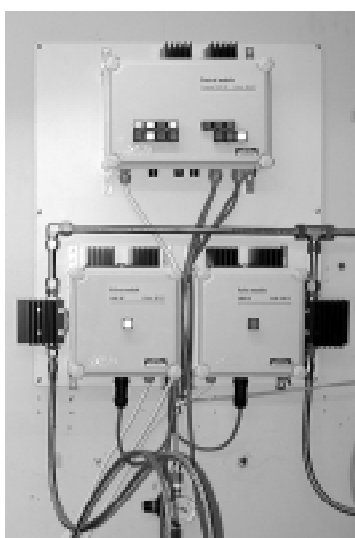

	Component	Code
each	Control module, 2-channel 240V AC	MLR2
each	Valve module, 240V AC	MLV1
each	Drum, stainless steel, 200LT, pressurisable to 5 bar, with level sensor	MF200
	Accessories:	
each	Drum Trolley	MDT1

Drum, stainless steel, LiQuiSure

Closed top drums of fully welded and crevice-free construction suitable for the storage of high purity solvents. Original purity is maintained as the solvent is in contact only with high grade 304 stainless steel. UN-approved for international transport of dangerous goods, they are very robust in use and suitable as re-useable and returnable packaging. The top features standard 2" and 3/4" Trisure closures permitting a number of dispensing options.



	Nominal Capacity	Diameter	Height	Weight	Code
each	200 LT	570 mm	920 mm	25 KG	PD02

Drum, stainless steel, LiQuiSure pressurisable

Closed system drums fabricated from high grade stainless steel. May be pressurised up to 5 bar for dispensing by gas pressure. Wall thickness is 2.5 mm. The concave base allows for maximum liquid recovery. The top is fitted with quick-release couplings (1) to facilitate easy connection to and disconnection from solvent delivery lines. Whilst Swagelock couplings are recommended, other brands can be fitted according to customer preference. A protective cap (2) prevents damage to these couplings during transport. An optional level sensor gives an indication of when the drum is (almost) empty and needs to be changed. When fitted with this option, these drums form part of an automated dispensing system for high purity solvents (see Dispensing System, automated, LiQuiSure). Also UN-approved for international transport of dangerous goods they are an ideal container for packaging waste free supply of bulk high purity solvents.

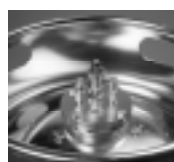
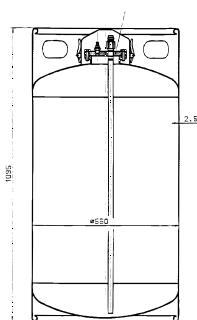

1



2

	Nominal Capacity	Diameter	Height	Weight	Code
each	200 LT	550 mm	1095 mm	58 KG	MF200

Flask, stainless steel, LiQuiSure

Robust environmentally friendly flasks of stainless steel suitable as returnable and reusable packaging. Liquid is in contact only with grade 304 stainless steel and PTFE so maintains original purity of ROMIL-SpS™ Super Purity Solvents and HPLC Eluants. Features UN-approval for international transport of hazardous goods. Discharging is by simple pouring out or with a special screw-on dispenser (see Dispenser, stainless steel, LiQuiSure). Neck thread is a standard GL/DIN/ISO 45 which takes a wide range of other dispensing options. A wall thickness of 1 mm permits light pressurisation to 0.3 bar. Supplied complete with standard ROMIL cap with PTFE wad.

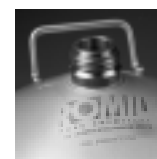
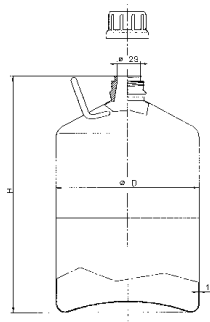

	Nominal Capacity	Actual Volume	Diameter	Height	Weight	Handle	Code
each	1 LT	1.3 LT	108 mm	185 mm	0.6 KG	no	PF01
each	2 LT	2.7 LT	140 mm	235 mm	0.9 KG	no	PF02
each	5 LT	6.1 LT	181 mm	300 mm	1.6 KG	yes	PF05
each	7 LT	7.8 LT	197 mm	325 mm	1.8 KG	yes	PF07
each	10 LT	12.2 LT	229 mm	365 mm	2.4 KG	yes	PF10
each	20 LT	22.0 LT	278 mm	460 mm	3.4 KG	yes	PF20

Accessories:

each	Bottle Cap, tamper-evident, PTFE wad, GL/DIN/ISO 45E	PC45E
------	--	--------------

Flask, stainless steel, LiQuiSure pressurisable

Robust environmentally friendly pressurisable flasks suitable as returnable and reusable packaging for semi-bulk quantities of high purity and anhydrous solvents. Original purity is maintained as the solvent is in contact only with high grade stainless steel. A range of fittings are available to facilitate easy dispensing by gas pressurisation from -1 to 5 bar. UN-approved for international transport of hazardous goods.

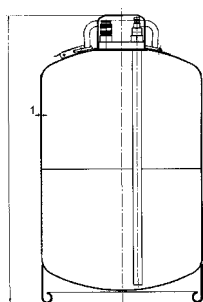

with PFCT

	Nominal Capacity	Diameter	Height	Weight	Handle	Code
each	5 LT	181 mm	331 mm	2.4 KG	yes	PP05
each	10 LT	229 mm	394 mm	3.7 KG	yes	PP10

IBC, stainless steel, LiQuiSure

Compact, non-framed, 304 stainless steel IBC. Plate thickness 2.5 mm. Designed for safe transport and handling of high purity solvents in bulk. These multi-trip IBCs provide an economical and durable solution to the problem of maximising storage space for all types of performance solvent. Fully UN-approved for transport of hazardous goods of packing group II and III. Maximum contents SG 1.8. 4-Way entry pallet base in galvanised mild steel. Suitable for forklift, pallet truck or crane handling.

Top fittings: Manway 400 mm & cover with 6 swing bolts and PTFE seal. 1" Pressure and vacuum relief vent, twin action, in s/steel 316. Opening pressure 0.21 bar. Opening vacuum 0.03 bar. Flame proof gauze.

Bottom fittings: 2" Ball valve in s/steel 316, 2 piece, full port, female BSP, lockable handle + chain + plastic cap. Earthing strap. Gradient of bottom 10°.



	Nominal Capacity	Width	Length	Height	Weight	Code
each	500 LT	1025 mm	1225 mm	810 mm	125 KG	PI05
each	800 LT	1025 mm	1225 mm	1110 mm	150 KG	PI08
each	1000 LT	1025 mm	1225 mm	1230 mm	165 KG	PI10
each	1200 LT	1025 mm	1225 mm	1425 mm	179 KG	PI12
each	1500 LT	1025 mm	1225 mm	1690 mm	201 KG	PI15
each	2000 LT	1025 mm	1225 mm	2130 mm	240 KG	PI20

Liquid Delivery Adaptor, LiQuiSure

Designed to enable the easy connection of ROMIL 100ml, 250ml, 500ml, 1LT, 2½LT and 4LT bottles and others with GL/DIN/ISO threads, to liquid delivery systems in automated instrumentation such as HPLC, DNA/RNA synthesis, protein sequencing, autotitrimetry and Karl Fischer analysis. Individually controlled valves allow for solvent or reagent delivery by either gas pressure or pump suction and the design also permits easy venting, flushing and degassing. Bottles may be pressurised to 5 psi (0.35 Kg cm⁻²) and for safety reasons the use of appropriate shielding protection when under pressure is strongly recommended. A tight fitting avoids hazardous solvents polluting the laboratory atmosphere thus ensuring safety for all laboratory personnel. The valves are fabricated from PTFE to ensure that only inert material is in contact with the liquid. Two 2-metre lengths of PTFE tubing of different diameter are supplied and can be cut to length according to requirements.



PAD45E



PAD32E

	Neck Thread	Valves	Code
each	32E	2	PAD32E
each	45E	3	PAD45E